



Important

Before assembling your light fixture, please make sure that you read through the instruction sheets. Have your fixture installed by a qualified licensed electrician.

NOTE: The important safeguards and instructions appearing in this manual are not meant to cover all possible conditions and situations that may occur. It must be understood that common sense, caution and care, are factors that can't be built into any product. These factors must be supplied by the person(s) caring for and operating the fixture.

General Information

All electrical connections must be in accordance with the local codes, ordinances or the National Electrical Codes.

These fixtures are intended for mounting to a standard 4" x 2 1/2" metal octagon outlet box.

The box must be directly supported by the building structure and U.L. Recognized.

Step By Step Instructions

Before starting your installation -Disconnect the Power by turning of the Circuit Breaker or by removing the fuse at the fuse box. Just turning the light off at the light switch is not sufficient to prevent electrical shock.

What you will need

- a screwdriver
- wire cutters
- wiring supplies as specified by electrical code

What we provide

- a fixture backplate
- mounting hardware
- glass shade with metal frame
- ballast
- 2 x 39W T5HO/3000k Bulbs

1 Drilling Holes for the Anchors

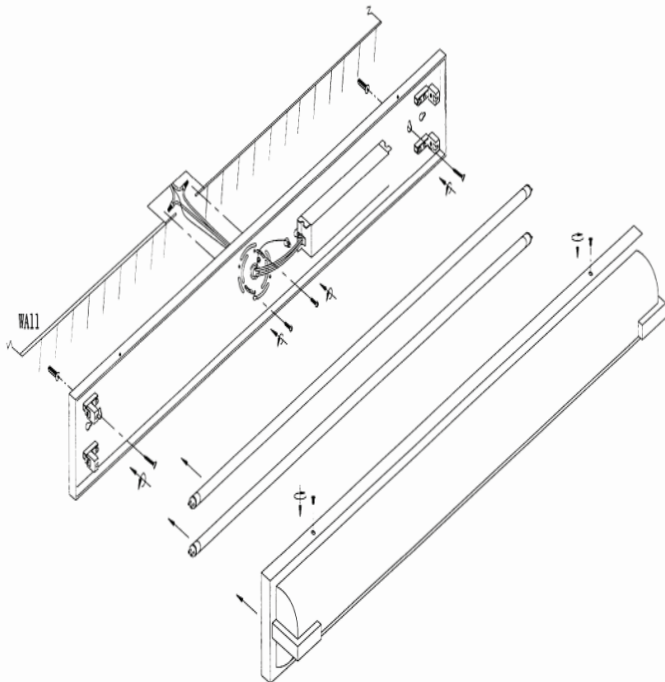

1

If there is an existing fixture remove it.

Expose the supply wire from the outlet box.



Hold the fixture back plate up to the wall and mark with a pencil the location for the additional support. Remove, and drill holes in the wall to accomodate the supplied hardware.

2

Pull the supply wires through the center hole in the back plate. Connect the black supply wires to the black fixture wires, the white supply wires to the white fixture wires and the ground wire (green) from the fixture to the outlet box ground terminal, or to the green screw. *Secure all of the wire connections with wire nuts.*



2 Connecting the Supply and Fixture

3 Mount the Sconce to the Back Plate

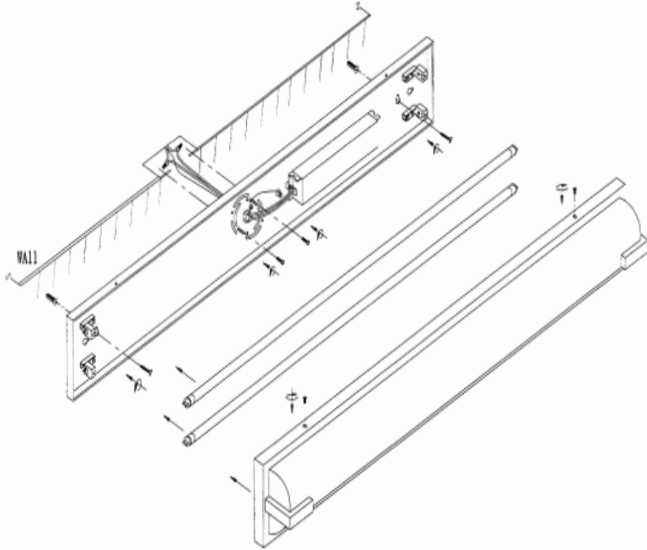

3



Position your fixture so that the holes in the back plate align with the holes in both the junction box and the anchors that you just inserted into the wall. Secure the back plate to the wall by inserting the supplied screws

4



Insert the supplied bulbs into the sockets.
Do not exceed the wattage stated on the warning label.

4 Insert the Bulbs

5 Attach the Glass Shade and Metal Frame

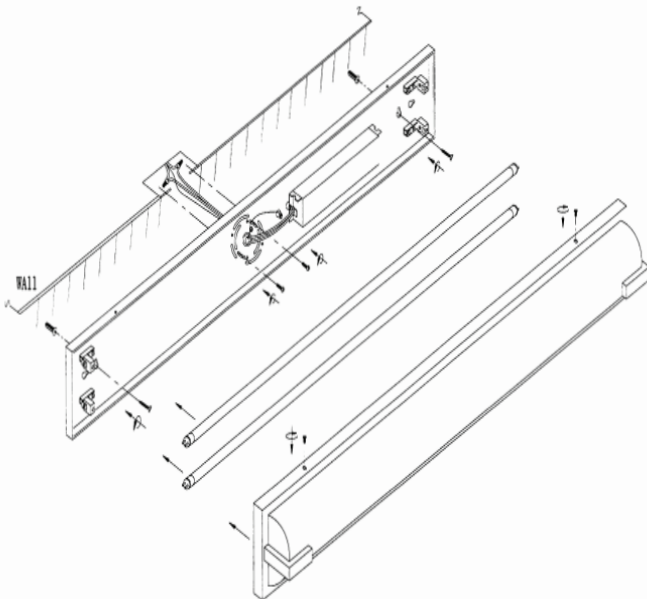

5



Secure the glass shade with metal frame to the fixture back plate by positioning the metal frame over the back plate. Align the holes at the top and bottom of the frame with the holes in the back plate. Insert the supplied screws and tighten down



Restore the electricity and check the operation of your new fixture

CAUTION

Ensure that the fitting is cool and switched off before replacing the bulb.

DO NOT use bulbs exceeding the maximum wattage, as per the caution label.