

STEP 4 - Fit Ceiling Canopy to Mounting bracket Assembly

A. Fit the ceiling canopy to Mounting Screws (DD) and secure with Cap nut (AA). Note: The ceiling canopy should be snug against the ceiling and the Mounting Balls (AA). If not, adjust the length of the Mounting Screws (DD) by unscrewing the Hex Nut and Lock Washer and then screwing Mounting Screws (DD) in or out of the Mounting bracket (EE) until the correct length is achieved. Once the ceiling canopy is secure, remove the Cap nut (AA) and ceiling canopy and proceed to Step 5.

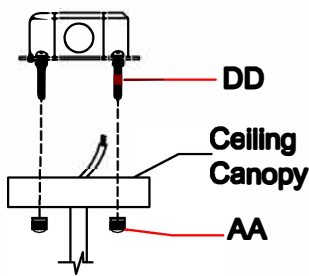

Figure 3

STEP 6 - Install Ceiling Canopy to Ceiling

A. Carefully tuck all wires into the outlet box and position the ceiling canopy of the Fixture Body (A) over the outlet box. Align the holes in the ceiling canopy with the Mounting Screws (DD). Secure with Cap nut (AA) and hand tighten until snug.

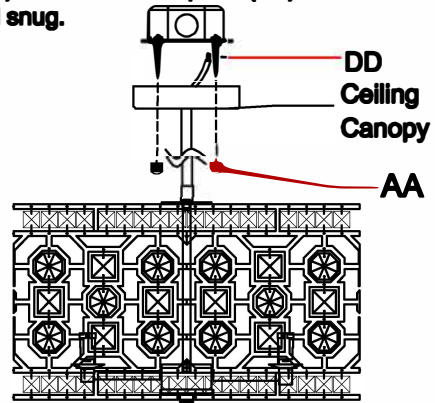

Figure 5

STEP 5 - Wire Connections

A. Use standard wire connectors to make all wire connections. Twist connectors until wires are tightly joined together. Wrap each connection with approved electrical tape and carefully stuff all the connected wires into the Outlet Box.

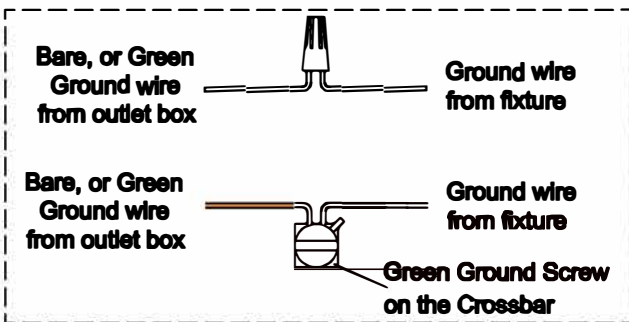
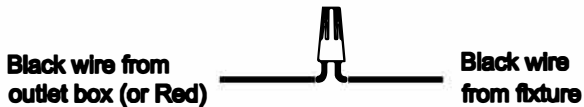
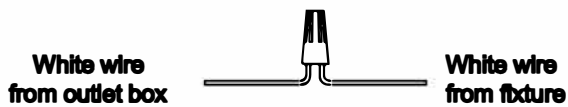

Figure 4

STEP 7 - Install Bobeches , Socket sleeve and Bulbs.

A. Place bobeches and Socket sleeve over sockets as shown. B. Install bulbs onto sockets and push snug into place.

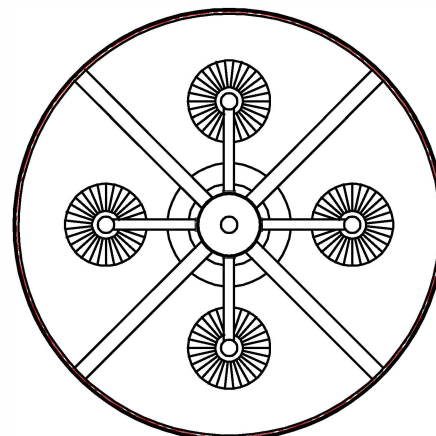
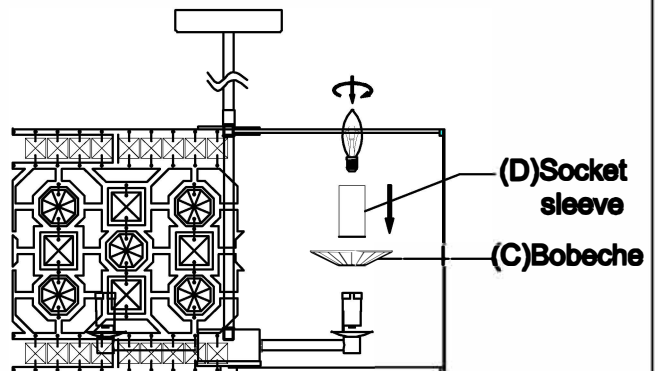

Figure 6