

Installation manual for

1705D42SDG

Dimensions : D42"*H5"
Collection : Malta Hang
Bulb Type : LED strip 56W 3000K
Lamp Frame Weight : 28 LBS
Total Weight : 36.3 LBS

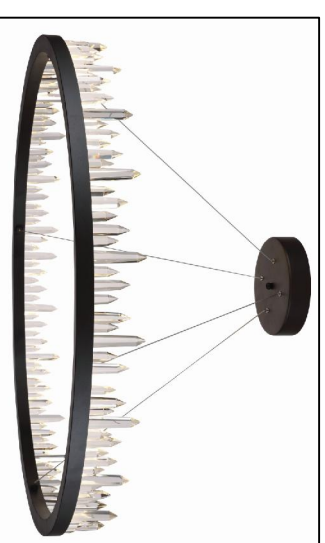

Thank you for choosing our product(s).
Our Company is actively involved in every step of the production.

Our product(s) are designed to be utilized for every application that graces your home or business. We pride ourselves in providing the most prompt and courteous service to all of the valued customers. Please find the enclosed detailed instruction and read carefully for proper installation. If you have any questions, our professional customer service team is committed to assisting you, please call our toll free HOTLINE AT:

1-888-388-3390



WARNING: MAKE SURE THE ELECTRICITY TO THE WIRES YOU ARE WORKING ON IS SHUT OFF BY EITHER REMOVING THE FUSE OR TURN OFF THE CIRCUIT BREAKER.

SAFETY

CAUTION

- Before assembling the lighting fixture, please read all instructions carefully.
- All frame & crystal components are fragile, please handle with care.
- Required supply circuit : 110 - 130V/60Hz.
- Labeled wires are "L" for live wire, "N" for neutral wire, "E" for ground wire.
- Never install fixture on damp ceiling, the room should be dry and well ventilated.
- All electrical components must be installed by a licensed electrician and in accordance with the National Electrical Code and the appropriate local electrical codes.

UNPACK THE PACKAGE

Please open the box carefully and check all the items are inside the box. If you have any installation, assembling and missing parts questions, please call our Customer Service department at 1-888-388-3390. Please have model number (at the front page), where you purchase from and any other relevant information ready, our customer service team will provide comprehensive and worry free service to our valued customers.

Frame Assembly Diagram

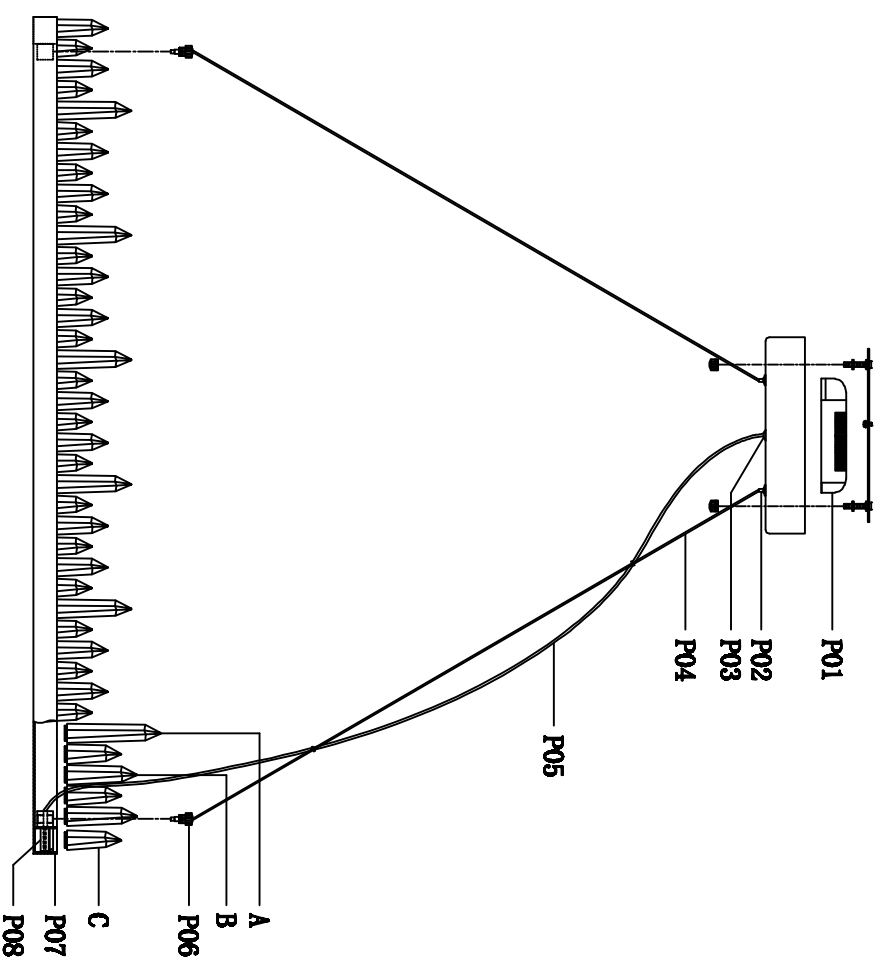















1705D42 D42"×H5"

Step 1



Please use the parts list to ensure you are not missing any parts.

1705D42

PARTS LIST

Part	Picture	Description	Qty	Check list
ZA		Junction box not included	1	
ZB		Crossbar D8.7'	1	
ZC		Crossbar Screws	2	
ZD		Ceiling Plate (D9.8'×H2')	1	
ZE		Nut	4	
ZF		ground wire	1	
ZG		junction caps	2	
P01		LED Driver	1	
P02		steel wire locker	4	
P03		Cable protector	1	
P04		159' Steel Wire	4	
P05		Steel Cable 174.5'/18#	1	
P06		Nut	4	
P07		D42' 'U' shape lamp body	1	
P08		L137.8' LED strip	1	

1705D42 D42"×H5"

Part	Picture	Description	Qty	Check list
A		H4.8' Crystal	24	
B		H3.6' Crystal	48	
C		H2.8' Crystal	71	

1705D42 D42"*H15"

Part	Picture	Description	Qty	Check List

05

1705D42 D42"*H15"

Step 2
Canopy Installation Instruction

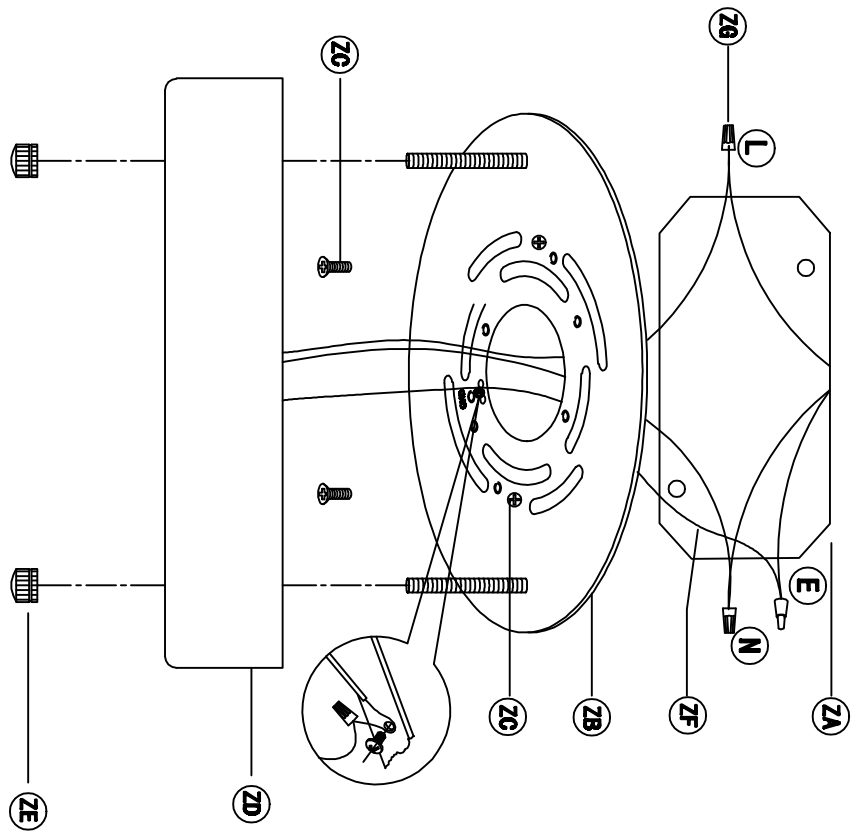

06

1705D42 D42*#H5"

IMPORTANT: Test sockets with bulb before dressing the fixture.

1. Attach the Crossbar (ZB) to the Junction Box (ZA) using the two crossbar screws (ZC) which are not supplied and should already be in your box.
2. Be sure when connecting the wire use electrician approved junction caps (ZG).
3. Stow the excess wire in the junction box (ZA).
4. Mounting screws (ZE), attach the fixture to the ceiling.

07

1705D42 D42*#H5"

Step 3

Frame Assembly Diagram

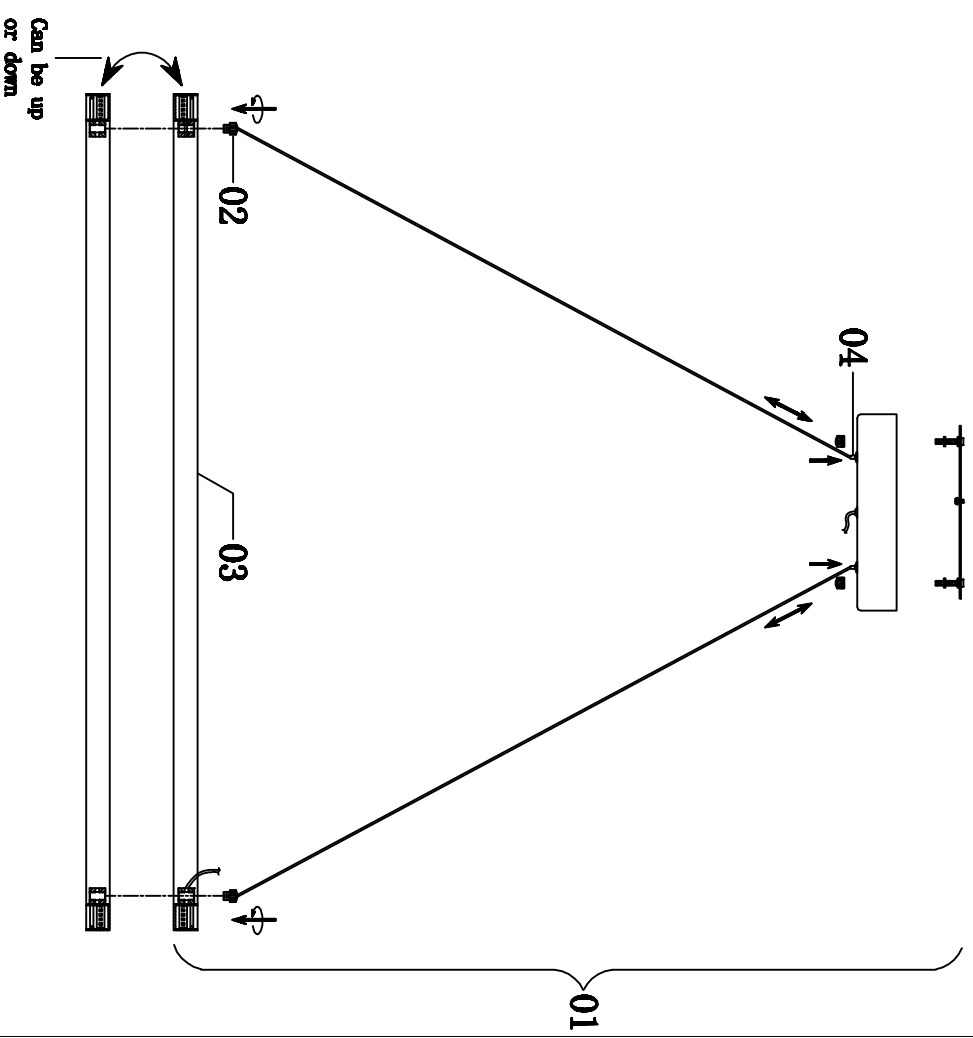

08

Frame Assembly Instructions

Installation:

Please read all instructions carefully.

Before you proceed to install, make sure that the power supply is turned off and remains off until installation is complete. Please note that each part has been assigned a number. Please proceed in a numerical order.

1. Before installation, Release the Screw (02) , to adjust the “U” shape Lamp body(03) up or down by your wish, after adjusted the lamp body down or up, tighten the screw(02) and fix on the “U” shape lamp body(03).
2. Fixed the Ceiling Cover on the Mounting Bracket (01), then put the screws tightened.
3. Push the steel wire locker(04), to adjust the length of the sttel wire.

Crystal Dressing Diagram

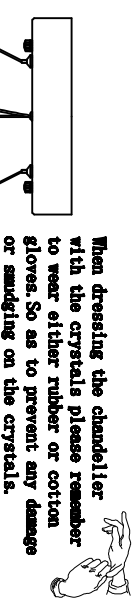

1. Put the crystals A, B, C as the drawing picture above in the “U” shape Lamp body(A-C-B-C-B-C).

1705D42 D42"*H5"

Congratulations !

You are now done installing your
Elegant Lighting fixture. Sit back
and admire each crystal as it will
become the statement piece for
your room/house.

If you require any additional
assistance, please contact us at
1-888-388-3390.

Thank you.

11

1705D42 D42"*H5"

Cleaning and Maintenance of Chandelier Frame
The finish on our chandelier frames and fixture
frames is protected by a durable coating of
lacquer. To clean, use a clean soft, dry cloth. Do
not use any metal polishes, cleaners, abrasives
or any substance which could remove the
protective finish. Failure to follow these
instructions automatically voids the guarantee.

Cleaning and Maintenance of Crystals

Wet a soft cotton fabric in clean warm water and
wipe gently, then polish with a dry soft cotton
fabric.

To Order Crystal Replacement Parts

Should you require replacement crystals or pins
(the metal connectors attaching the crystals),
contact the store where the product was
purchased or contact us at the address shown on
the reverse side. For ease of ordering, you may
use the original crystal trimming instructions
provided with this product and circle the items
you wish to order, indicating the quantity by
writing the number needed adjacent to the circle
and faxing it to our customer service department
at 215-423-8882. You will be contacted with
prices prior to shipment. All orders must be
pre-paid.

12

Elegant Lighting Warranty

The finish and frame of your new chandelier or fixture are warranted for a period of two (2) years from the date of purchase. Our company will, at its option, repair or replace any frame that has a defect in the materials or workmanship during the warranty period. All crystals are guaranteed for their original quality during the life of the chandelier. Breakage is not covered by this warranty.

To make a claim under this warranty, contact our customer service department at the address and phone number shown below. A written return authorization form will be sent to you with specific instructions.

CUSTOMER SERVICE DEPARTMENT
500-550 E. Erie Avenue
Philadelphia, PA 19134
Tel : 215-423-8880
Fax : 215-423-8882

Returns and Conditions of Warranty

Returns must be pre-authorized by contacting our customer service department at the address on the reverse side. Returns will only be accepted with a written return merchandise authorization and return shipping charges pre-paid. We reserve the right to inspect all returned merchandise to fully determine the nature of any defect. This guarantee shall not apply to any product that has been changed, altered or otherwise modified, nor shall it apply to any product that has been repaired or altered by anyone other than a pre-authorized facility. We will not be responsible for any breakage or damages incurred during transit, nor for crystal parts or metal frame part that have been subject to misuse, negligence, accident or inappropriate handling. Also, we will not be held responsible for damage incurred during improper installation or wiring by others, nor for damages resulting from a failure to follow the recommended maintenance or installation procedures. This guarantee is issued in lieu of any and all other guaranteed or warrantee, whether written or implied and any and all other obligations or liabilities. Further, we neither authorize nor permit any other person or firm to assume for us, any liability in connection with the sale of our products.