



ELEGANT
FURNITURE & LIGHTING™

Installation manual for

3500D5RC/G

Dimensions : D11.8"H9.2"L5

Collection : Polaris

Bulb Type : LED PCB 45W 3000K

Lamp Weight : 15.2 LBS

Total Weight : 16.9 LBS



Thank you for choosing our product(s).
Our Company is actively involved in every step of the production.

Our product(s) are designed to be utilized for every application that graces your home or business.

We pride ourselves in providing the most prompt and courtesy service to all of the valued customers.

Please find the enclosed detailed instructions and read carefully for proper installation. If you have any

questions, our professional customer service team is committed to assisting you, please call our toll free

HOTLINE AT:

1-888-388-3390



SAFETY
Warning: MAKE SURE THE ELECTRICITY TO THE WIRES YOU ARE WORKING ON IS SHUT OFF. BY EITHER REMOVING THE FUSE OR TURNING OFF THE CIRCUIT BREAKER.

CAUTION

- Before assembling the lighting fixture, please read all instructions carefully.
- All frame & crystal components are fragile, please handle with care.
- Required supply circuit : 110 - 130V/60Hz
- Labeled wires are "L" for live wire, "N" for neutral wire, "E" for ground wire.
- Never install fixture on damp ceiling, the room should be dry and well ventilated
- All electrical components must be installed by a licensed electrician and in accordance with the National Electrical Code and the appropriate local electrical codes.

Unpack the Package

Please open the box carefully and check all the items are inside the box. If you have any installation, assembling and missing parts questions, please call our Customer Service department at 1-888-388-3390. Please have model number(at the front page), where you purchase from and any other relevant information ready, our customer service team will provide comprehensive and worry free service to our valued customers.

01

Frame Assembly Diagram

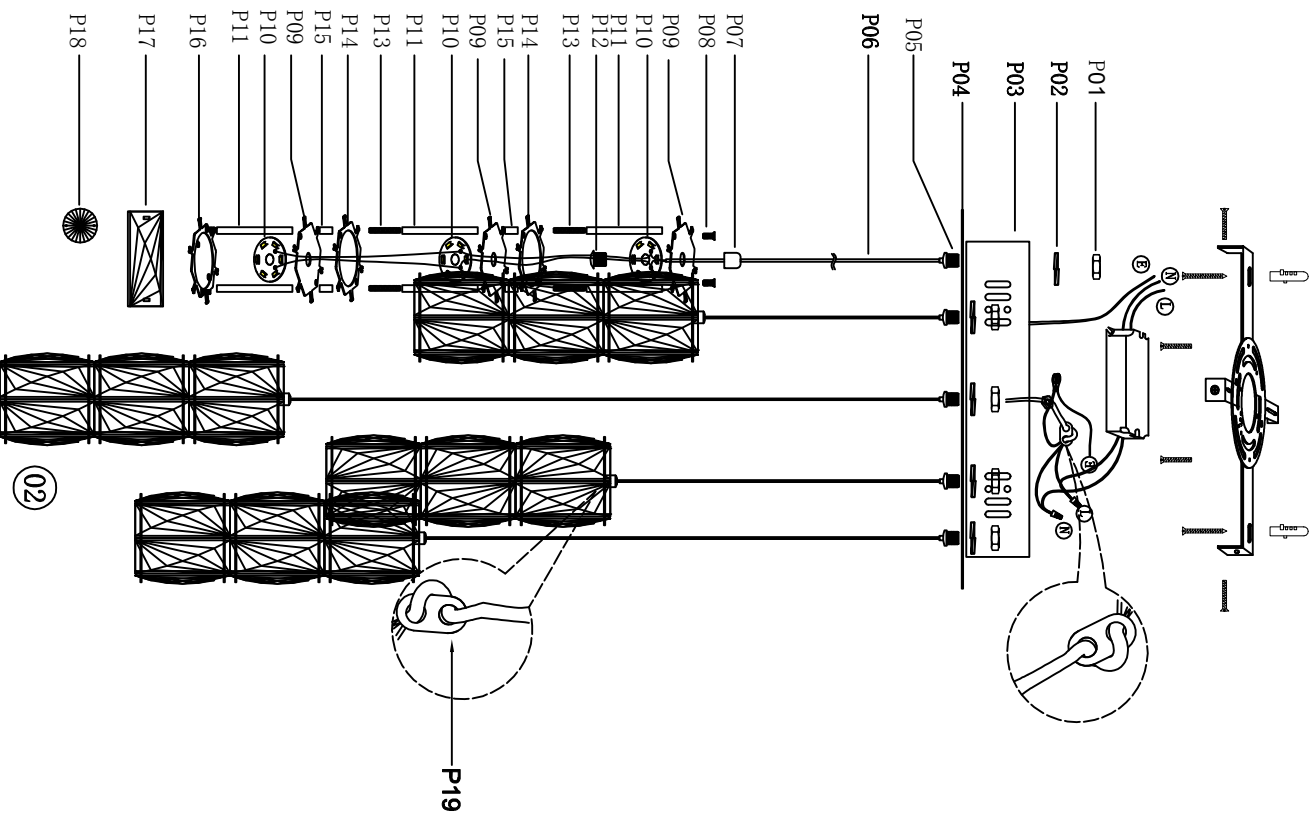









02

3500D5R D11. 8"H9. 2"L5













Step 1
Please use the parts list to ensure you are not missing any parts.

3500D5R PARTS LIST

Part #	Picture	Description	Qty	Check list
ZA		bracket system	1	
ZB		M4*15 screw	4	
ZC		M4*32 screw	3	
ZD		M4*40 screw	2	
ZE		dimnable LED driver	1	
ZF		junction caps	3	
ZG		plastic anchor screw	2	
P01		M10*T5 nut	5	
P02		screw pad	5	
P03		D9.8"H1.5" canopy box	1	
P04		phi 11.8" S.S plate	1	
P05		M10*20 connector	5	
P06		0.3mm ² *63" electrical wire	1	
		0.3mm ² *70.7" electrical wire	1	
		0.3mm ² *78.7" electrical wire	1	

03

3500D5R D11. 8"H9. 2"L5

Part #	Picture	Description	Qty	Check list
		0.3mm ² *86.6" electrical wire	1	
		0.3mm ² *94.5" electrical wire	1	
P07		phi 12*H13 wire fixer	5	
P08		M4*8 screw	10	
P09		2.8" stainless steel crystal fixer	15	
P10		LED PCB (lighting source)	15	
P11		2.8" metal pipe	30	
P12		M10*10 plastic screw	5	
P13		M4*25 threaded rod	20	
P14		2.8" stainless steel crystal fixer	10	
P15		phi 5.3*10 steel pipe with thread inside	20	
P16		2.8" stainless steel crystal fixer	5	
P17		1.2"3" crystal polyhedron	90	
P18		45# crystal	5	
P19		14*10*2.5mm	10	

04

Step 2

Canopy Installation Instruction

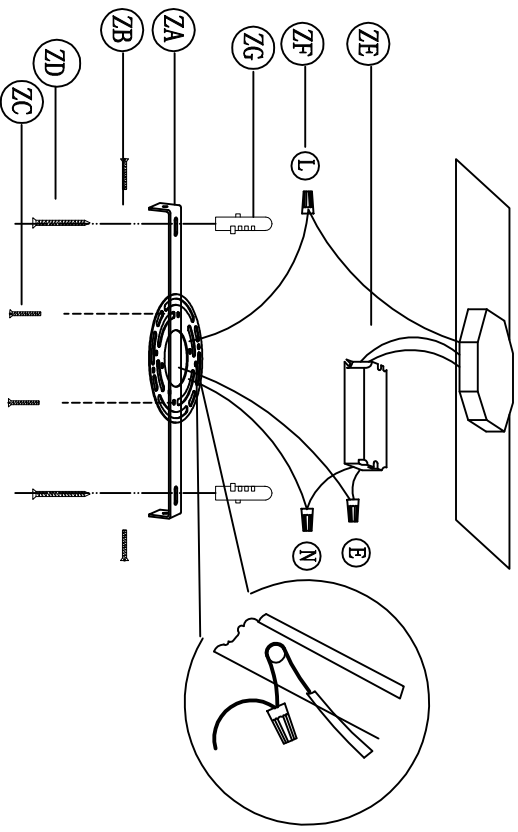

1. Drill two holes on the ceiling and put the plastic anchor screw (ZE) into the holes (If the wall is wood made, this step can be ignored) ;
2. Attach the Bracket (ZA) to the Junction Box with two screws (ZC).
3. Fix the bracket on the ceiling with screws (ZB)
4. Connect the wires with electrician approved junction caps (ZF).

05

Step 3

Frame Assembly Diagram

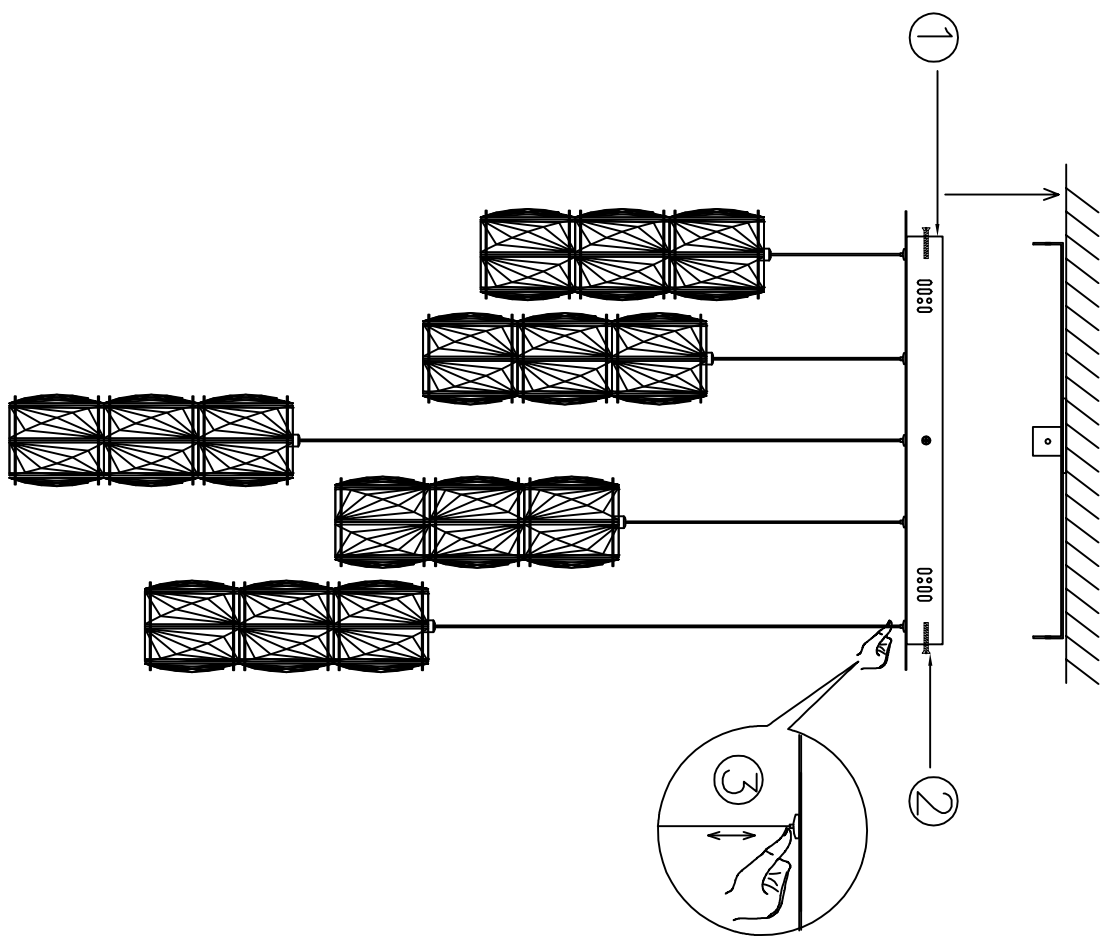

06

Frame Assembly Instructions

Installation:

Please read all instructions carefully, before you proceed to install. Make sure that the power supply is turned off and remained off until the installation is completed. Please note that each step has been assigned a number. Please proceed following the numerical order.

1. put the fixture on the bracket;
2. fix the fixture on the bracket with screw (ZD);
3. press down the metal pipe on the wire adjuster (P05), adjust the height of the lamp by push up or pull down the wire(P06). Release (P05), the wire length will be kept.

Congratulations!

You are now done installing your Elegant lighting fixture. Sit back and admire each crystal as it will become the statement piece for your room/house.

If you require any additional assistance, please contact us at 1-888-388-3390.

Thank you!

07

Cleaning and Maintenance Instruction

The frame and canopy surface is stainless polished.

Please use a clean, soft and dry cloth to clean. Do not use any hard object or tools to scratch on the surface of the metal. Failure to follow these instructions automatically voids the guarantee.

Cleaning and Maintenance of Crystals

Wet a soft cotton fabric in clean warm water and wipe gently, then polish with a dry soft cotton fabric.

To Order Replacement Parts

Please contact the store where the product was purchased or contact us at the address shown on the reverse side.

For ease of ordering, you may use the original parts list , indicating the model number, part number and quantity and faxing it to our customer service department at 215-423-8882. You will be contacted with prices prior to shipment. All orders must be pre-paid.

08

Elegant Lighting Warranty

The finish and frame of your new chandelier or fixture are warranted for a period of two (2) years from the date of purchase. Our company will, at its option, repair or replace any frame that has a defect in the materials or workmanship during the warranty period. All crystals are guaranteed for their original quality during the life of the chandelier. Breakage is not covered by this warranty.

To make a claim under this warranty, contact our customer service department at the address and phone number shown below. A written return authorization form will be sent to you with specific instructions.

CUSTOMER SERVICE DEPARTMENT
500-550 E. Erie Avenue
Philadelphia, PA 19134
Tel : 215-423-8880
Fax : 215-423-8882

Returns and Conditions of Warranty

Returns must be pre-authorized by contacting our customer service department at the address on the reverse side. Returns will only be accepted with a written return merchandise authorization and return shipping charges pre-paid. We reserve the right to inspect all returned merchandise to fully determine the nature of any defect. This guarantee shall not apply to any product that has been changed, altered or otherwise modified, nor shall it apply to any product that has been repaired or altered by anyone other than a pre-authorized facility. We will not be responsible for any breakage or damages incurred during transit, nor for crystal parts or metal frame part that have been subject to misuse, negligence, accident or inappropriate handling. Also, we will not be held responsible for damage incurred during improper installation or wiring by others, nor for damages resulting from a failure to follow the recommended maintenance or installation procedures. This guarantee is issued in lieu of any and all other guaranteed or warrantee, whether written or implied and any and all other obligations or liabilities. Further, we neither authorize nor permit any other person or firm to assume for us, any liability in connection with the sale of our products.