

Features

- The K-1122-XHGH bath offers both a whirlpool hydromassage and Heated BubbleMassage™ air bubbles for a truly relaxing bathing experience.
- 118 airjets release thousands of heated bubbles that surround and support the body in a warm massage.
- Purge cycles remove residual water from air channels after use to keep the system clean.
- Variable-speed blower lets you adjust Heated BubbleMassage™ massage intensity to 18 levels.
- Single-speed whirlpool revitalizes sore muscles.
- 8 fully adjustable whirlpool jets allow users to customize hydromassage flow and direction at each jet.
- Comfort Depth® design offers a convenient 19" step-over height while retaining the same depth as a standard 21" bath.
- Molded lumbar support offers extra comfort while bathing.
- Slotted overflow allows for deep soaking.
- Bottom surface manufactured with textured appearance.
- Reversible drain.
- Coordinates with other products in the Archer® collection.

Material

- Acrylic.

Hydrotherapy

- Heated BubbleMassage™.
- Whirlpool.

Technology

- Built-in 600W BubbleMassage™ heater warms humidified air before it enters the bath.
- Bath includes auto purge (after bath drains) and manual purge cycles to remove residual water and keep system clean.
- Auto-shutoff timer on blower allows users to enjoy Heated BubbleMassage™ experience for 60 minutes before turning off.
- User interface: electronic keypad control for Heated BubbleMassage™; air switch actuator for whirlpool.

Required Products/Accessories

K-7271 Brass Slotted Overflow Bath Drain

or

K-7272 PVC Slotted Overflow Bath Drain

Recommended Products/Accessories

K-24916 Wireless Music Kit

K-1446 Remote Installation Kit



ADA

Codes/Standards







ASME A112.19.7/CSA B45.10
CSA B45.5/IAPMO Z124
ASTM E162
ASTM E662
UL 1795
CSA C22.2 No. 218.2
ADA
ICC/ANSI A117.1

**KOHLER® Plastic Baths and Receptors
Lifetime Limited Warranty
KOHLER® Hydrotherapy Components
Five-Year Limited Warranty**

See website for detailed warranty information.

Available Colors/Finishes

Color tiles intended for reference only.

Color	Code	Description
	0	White
	96	Biscuit
	47	Almond
	NY	Dune
	95	Ice™ Grey
	58	Thunder™ Grey
	7	Black Black™

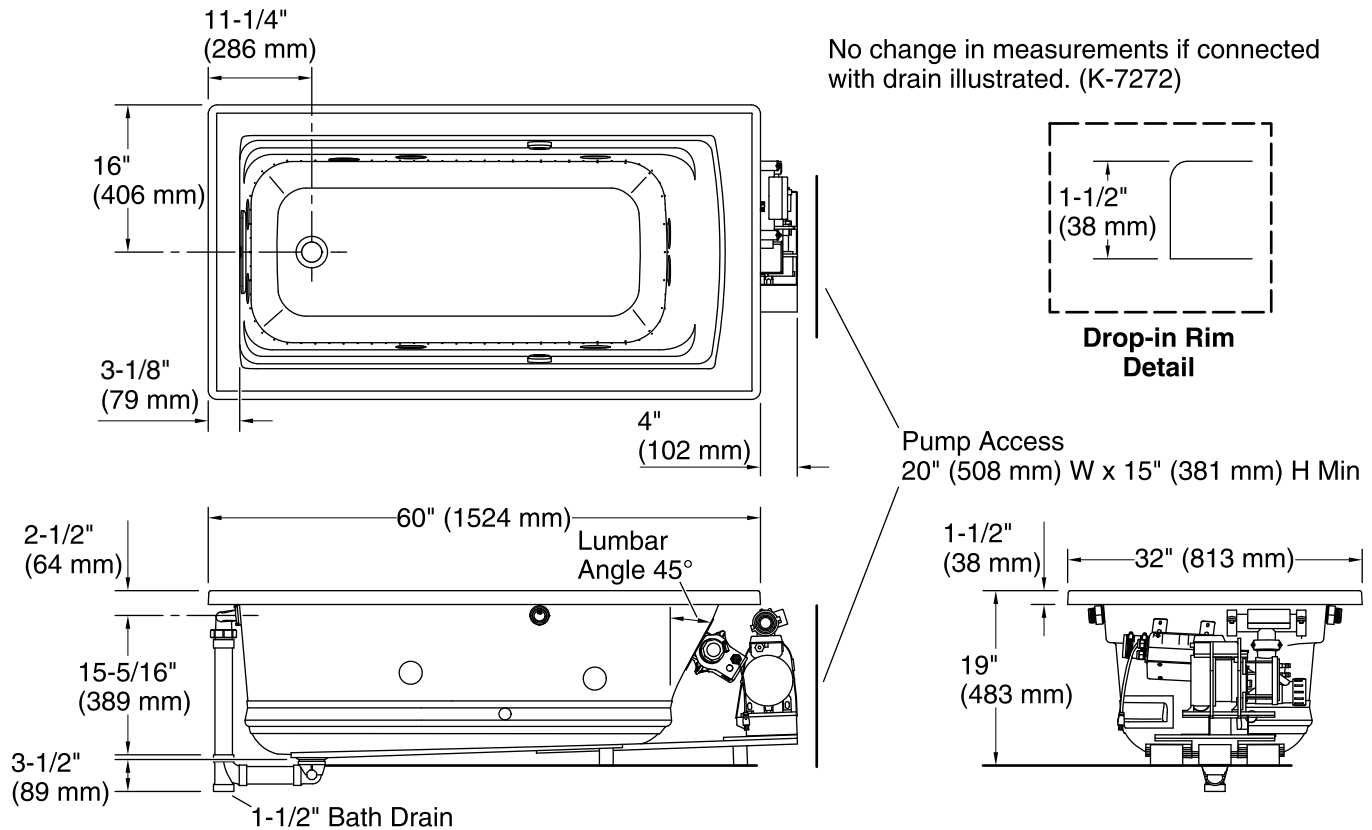

Required Electrical Service

Three dedicated circuits required, protected with Class A Ground-Fault Circuit-Interrupter (GFCI). Outside North America, this device may be known as a Residual Current Device (RCD).

Pump, Heater:	120 V, 15 A, 60 Hz
Heater:	120 V, 15 A, 60 Hz
Blower:	120 V, 15 A, 60 Hz

Technical Information

All product dimensions are nominal.

Installation:	Drop-in
Drain location:	End
Basin area, bottom:	45-1/8" x 19-11/16" (1146 mm x 500 mm)
Basin area, top:	52-3/4" x 25-5/16" (1340 mm x 643 mm)
Weight:	160 lbs (72.6 kg)
Minimum floor load:	47.5 lbs/ft ² (231.9 kg/m ²)
Water depth:	15" (381 mm)
Water capacity:	58 gal (219.6 L)
Cutout:	Drop-in, 58-1/2" x 30-1/2" (1486 mm x 775 mm)
Electrical component rating:	Pump: 120 V, 7 A, 60 Hz Heater: 120 V, 5 A, 60 Hz

Notes

Measure your actual product for rough-in details. Install this product according to the installation instructions.

The hot water supply should be 70% of the capacity of the bath or greater. Installations will vary.

Provide one grounded electrical outlet within 24" (610 mm) of each component.

This product is designed for drop-in installation only. It is not suited for use in a three-wall alcove with an overhead shower.

Remote blower installation kit is available for relocating the blower. Provide access for servicing the blower.

Do not relocate or alter the PVC tee or coiled flexible tubing connected to the blower. Follow the blower relocation instructions exactly.

ADA compliant when installed to the specific requirements of these regulations.