

Features

- For use with a handshower and hose (sold separately).
- Includes check valve for backflow prevention.
- Coordinates with Forté faucets and accessories.

Material

- Brass construction.
- KOHLER finishes resist corrosion and tarnishing.

Installation

- Wall-mount.



Codes/Standards







ASME A112.18.1/CSA B125.1

KOHLER® Faucet Lifetime Limited Warranty

See website for detailed warranty information.

Available Colors/Finishes

Color tiles intended for reference only.

Color	Code	Description
	CP	Polished Chrome
	SN	Vibrant® Polished Nickel
	AF	Vibrant® French Gold
	G	Brushed Chrome
	BN	Vibrant® Brushed Nickel
	BV	Vibrant® Brushed Bronze
	2BZ	Oil-Rubbed Bronze

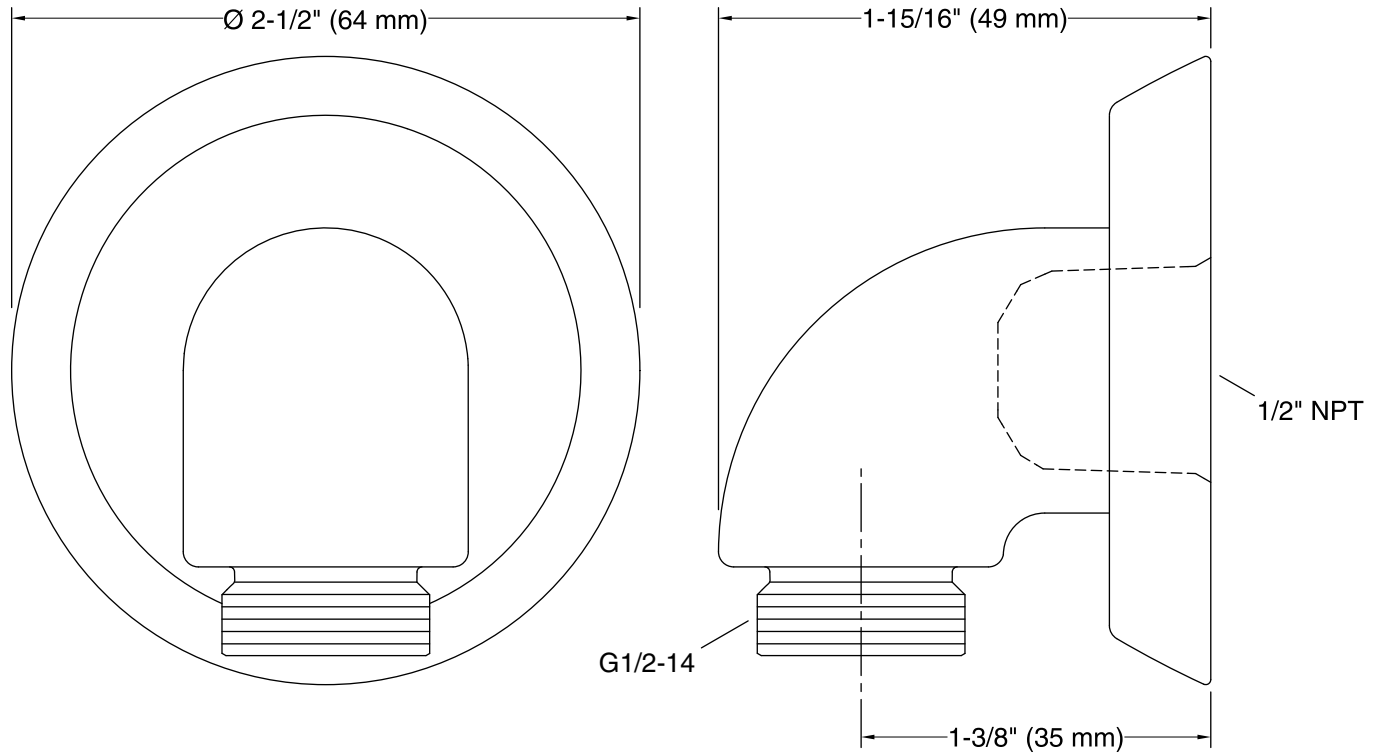

Technical Information

All product dimensions are nominal.

Notes

Install this product according to the installation instructions.