

## Features

- Fits minimum 36" (914 mm) apron sink base cabinet
- 9-1/2" (241 mm) depth provides generous workspace
- Apron designed to fit in standard 36" apron-front cabinetry
- Textured geometric faceted design
- Matte finish offers rich, dimensional color
- Offset drain increases workspace in the sink and storage space underneath
- Self-Trimming® apron overlaps cabinet face for easy installation and beautiful results

## Material

- KOHLER Neoroc® composite is durable and built to withstand day-to-day cleaning tasks
- Solid color throughout the sink
- Scratch-, stain-, chip-, and thermal-shock-resistant
- Heat-resistant up to 750°F

## Installation

- Undermount

## Recommended Products/Accessories

- K-8801 Sink drain and strainer with tailpiece
- K-8799 Sink drain and strainer basket

## Optional Products/Accessories

- K-11352 Disposal Flange with Stopper
- K-9000 P-Trap

## Included Components

- Additional Components:  
26026  
30182



## Codes/Standards







CSA B45.5/IAPMO Z124

## KOHLER® Neoroc® Sinks Lifetime Limited Warranty

See website for detailed warranty information.

## Available Colors/Finishes

*Color tiles intended for reference only.*

Color	Code	Description
	CM6	Matte White
	CM7	Matte Graphite
	CM1	Matte Black
	CM2	Matte Brown
	CM3	Matte Taupe
	CM4	Matte Grey

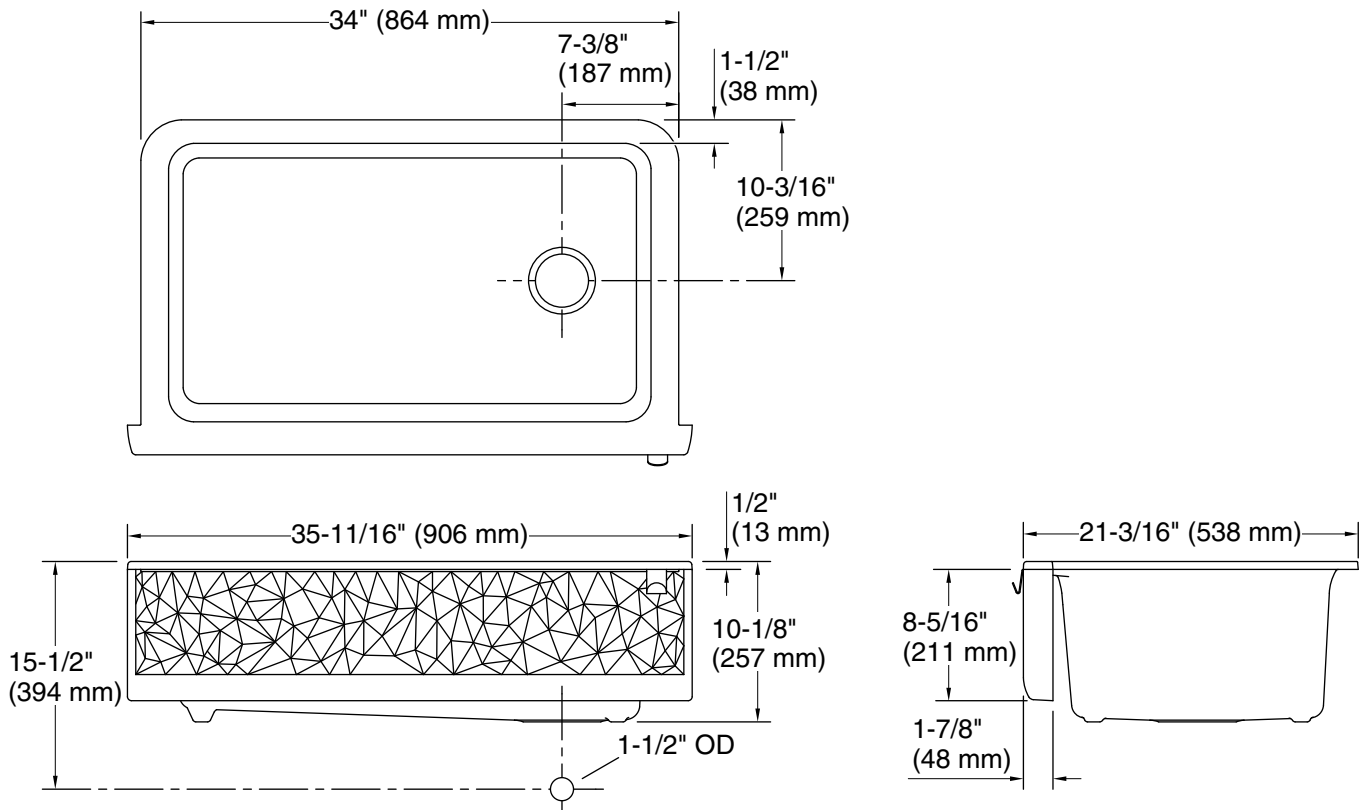

### Technical Information

All product dimensions are nominal.

Bowl configuration:	Single
Installation:	Undermount
Min. base cabinet width:	36" (914 mm)
Bowl area (Only):	Length: 28-5/8" (726 mm) Width: 15-1/2" (394 mm) Bowl depth: 9-1/2" (241 mm) Water depth: 9-1/2" (241 mm)
Drain hole:	3-7/8" (98 mm)
Template:	Apron-front, 1400299-7, required, included

### Notes

Install this product according to the installation instructions.

**NOTICE:** Countertop manufacturer or cutter must use the cut-out template provided with the product, or a current one provided by Kohler Co. (call 1-800-4-KOHLER). Kohler Co. is not responsible for cutout errors when the incorrect cut-out template is used.

**IMPORTANT!** The distance from the top edge of the cabinet to the top of the cabinet door must be at least 9" (229 mm) to install this sink.