

### Features

- Two-piece toilet.
- Round-front bowl offers an ideal solution for smaller baths and powder rooms.
- Comfort Height® feature offers chair-height seating that makes sitting down and standing up easier for most adults.
- 1.28 gallons per flush (gpf).
- 2-1/8-inch glazed trapway.
- Standard left-hand Polished Chrome trip lever included.
- Combination consists of the K-4347 bowl and the K-4166 tank.
- Coordinates with other products in the Cimarron collection.
- Light-touch canister flush requires a lower actuation force than a flapper

### Technology

- Single-flush gravity uses the force of gravity and a precision-engineered tank, bowl, and trapway to create a strong siphon during flushing.
- AquaPiston canister allows water to flow into the bowl from all sides (360 degrees), increasing the power and effectiveness of the flush.
- Flush valve's 3: 2 ratio harnesses the natural force of gravity and optimizes flush performance.
- Durable canister design has 90% less exposed seal material than a 3-inch flapper, for leak-free performance.
- Light-touch canister flush requires a lower actuation force than a flapper.
- AquaPiston canister flush valve optimizes flush performance and resists warping and deterioration.

### Installation

- Standard 12-inch rough-in.
- DryLock™ System saves installation time and helps prevent water leakage.
- Seat and supply line not included.

### Water Conservation & Rebates

- WaterSense® toilets meet strict EPA flushing guidelines, including using at least 20 percent less water than 1.6-gallon toilets.
- Eligible for consumer rebates in some municipalities.

### Recommended Products/Accessories

- K-4639 Cachet® Quiet-Close™ Round-Front Toilet Seat
- K-5589 Purefresh® Round-Front Toilet Seat
- K-76923 Puretide™ Quiet-Close™ round-front manual cleansing toilet seat
- K-5420 Low-Profile Bolt Caps
- K-9466-L Left-Hand Trip Lever
- K-9470-L Left-Hand Trip Lever



ADA CSA B651 OBC

### Codes/Standards







ASME A112.19.2/CSA B45.1  
DOE - Energy Policy Act 1992  
EPA WaterSense®  
California Energy Commission (CEC)  
ADA  
ICC/ANSI A117.1  
CSA B651  
OBC

### KOHLER® One-Year Limited Warranty

See website for detailed warranty information.

### Available Colors/Finishes

*Color tiles intended for reference only.*

Color	Code	Description
	0	White
	96	Biscuit
	47	Almond
	NY	Dune
	95	Ice™ Grey
	G9	Sandbar
	7	Black Black™

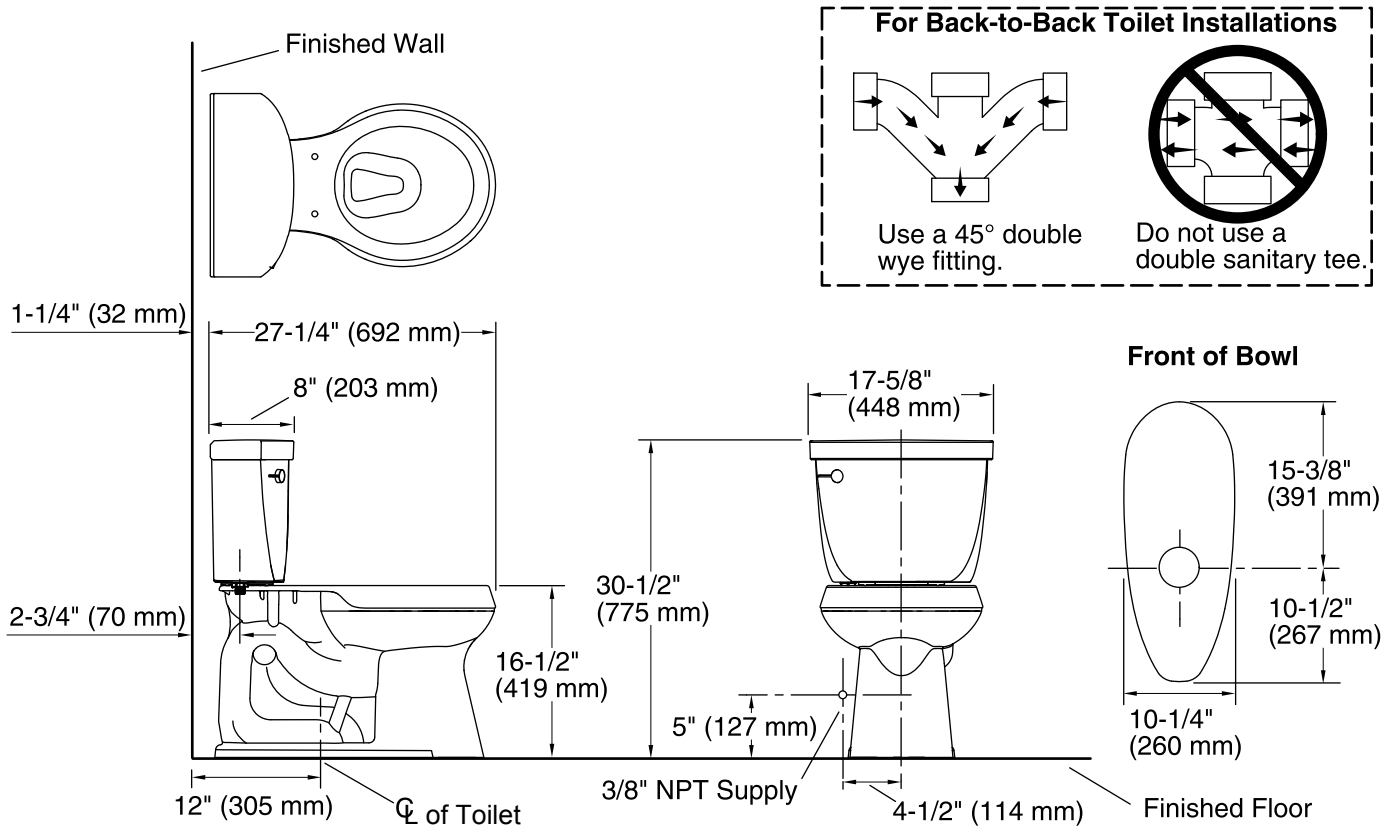

### Technical Information

All product dimensions are nominal.

Toilet type:	Two-piece, Floor-mount
Waste Outlet:	Floor
Bowl shape:	Round-front
Flush type:	AquaPiston®
Trap passageway:	2-1/8" (54 mm)
Water Consumption	
Full:	1.28 gpf (4.8 lpf)
Water surface size:	11" x 9-1/4" (279 mm x 235 mm)
Rim to water surface:	5-1/4" (133 mm)
Rough-in:	12" (305 mm)
Seat-mounting holes:	5-1/2" (140 mm)

### Notes

Install this product according to the installation instructions.

For back-to-back toilet installations: Use only a 45° double wye fitting.

The Model Plumbing Codes require elongated toilets for public bathrooms.

ADA, OBC, CSA B651 compliant when installed to the specific requirements of these regulations.

Plumbing codes may require elongated toilets and elongated, open-front seats in public bathrooms.

Accessibility standards may require controls to be located on the open side of the toilet.