

Features

- Vintage artisan-inspired top-mount handle provides a unique statement to any bathroom.
- KOHLER ceramic disc valves exceed industry longevity standards for a lifetime of durable performance.
- KOHLER ceramic disc valves exceed industry longevity standards for a lifetime of durable performance.
- Temperature memory allows faucet to be turned on and off at any temperature setting.
- High-temperature limit setting for added safety.
- Includes metal pop-up drain with 1-1/4" metal tailpiece.
- Coordinates with other faucets and accessories in the Artifacts collection.
- 1.2 gpm (4.5 lpm) maximum flow rate at 60 psi (4.14 bar).
- Tall height for vessel sinks.

Material

- Metal construction.
- KOHLER finishes resist corrosion and tarnishing.

Installation

- Single-hole mounting.

Recommended Products/Accessories

- K-23726 Drain treatment
- K-23723 Faucet cleaner



Codes/Standards







ASME A112.18.1/CSA B125.1
NSF/ANSI 61
NSF/ANSI 372
All applicable US Federal and State material regulations
DOE - Energy Policy Act 1992
EPA WaterSense®
California Energy Commission (CEC)

KOHLER® Faucet Lifetime Limited Warranty

See website for detailed warranty information.

Available Colors/Finishes

Color tiles intended for reference only.

Color	Code	Description
	CP	Polished Chrome
	SN	Vibrant® Polished Nickel
	BN	Vibrant® Brushed Nickel
	BV	Vibrant® Brushed Bronze
	2BZ	Oil-Rubbed Bronze
	2MB	Vibrant® Brushed Moderne Brass

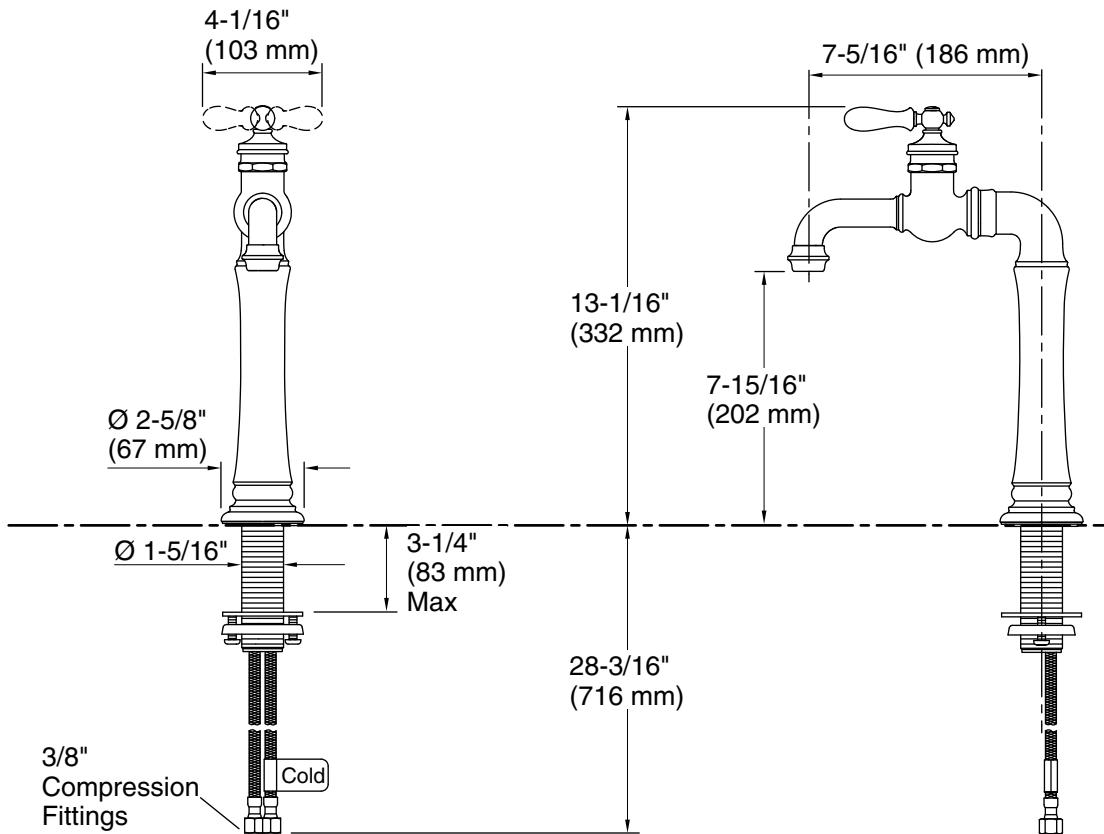

Technical Information

All product dimensions are nominal.

Faucet:

Flow rate: 1.2 gal/min (4.5 l/min)
 Pressure: 60 psi (4.1 bar)
 Valve body: Machined-brass
 Drain with overflow: Yes

Spout:

Spout reach: 7-5/16" (186 mm)

Notes

Install this product according to the installation instructions.

For new installations, assemble the faucet to the sink before installing the sink.