

Features

- Low-threshold design for easy entry and exit.
- Molded-in textured floor.
- Water containment bead incorporated into the threshold design provides an optimum barrier, preventing water from escaping from the shower space.
- Single threshold for alcove installation.
- Durable acrylic construction.
- Center drain.
- Coordinates with Choreograph® shower walls and other KOHLER® collections.



Recommended Products/Accessories

K-9132 Shower Drain

Codes/Standards

CSA B45.5/IAPMO Z124

ASTM E162

ASTM E662







KOHLER® Plastic Baths and Receptors

Lifetime Limited Warranty

See website for detailed warranty information.

Available Colors/Finishes

Color tiles intended for reference only.

Color	Code	Description
	0	White
	96	Biscuit
	47	Almond
	NY	Dune
	95	Ice™ Grey
	G9	Sandbar

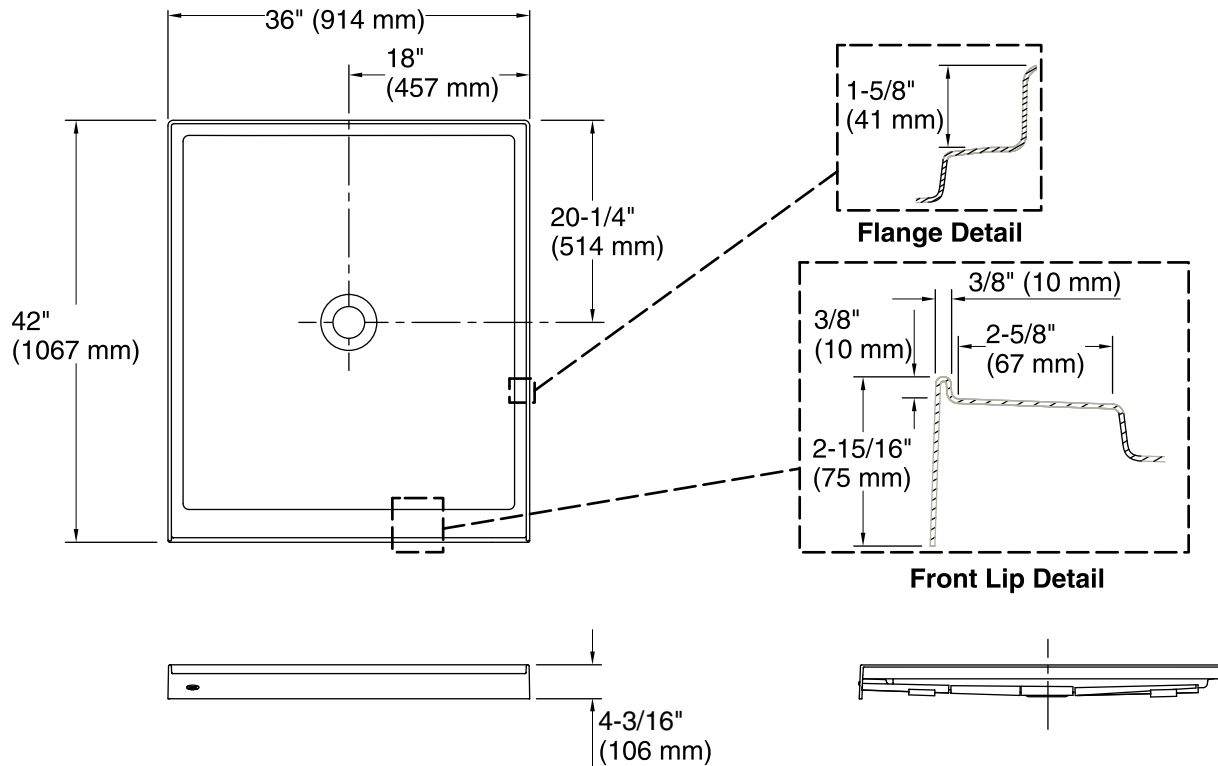

Technical Information

All product dimensions are nominal.

Installation: Three-wall alcove
 Drain location: Center
 Weight: 48 lbs (21.8 kg)

Notes

Measure your actual product for rough-in details. Install this product according to the installation instructions. Subfloor must be within 1/2" (13 mm) of level. This receptor has a front lip. This should be taken into account when installing a shower door.