

Features

- Pressure-balancing diaphragm technology maintains outlet temperature within +/-3 degrees Fahrenheit during water pressure fluctuations.
- Provides temperature regulation and automatic anti-scald protection.
- Single handle controls both on/off activation and temperature settings.
- Includes faceplate with ADA-compliant metal lever handle.
- Includes diverter bath spout with 1/2" NPT connection.
- Includes single-function 1.75 gpm (gallons per minute) showerhead with Katalyst® air-induction technology.
- Showerhead features MasterClean™ sprayface for easy cleaning.
- Coordinates with Devonshire® faucets and accessories.

Material

- Premium material construction with metal handle ensures reliability and durability.
- KOHLER finishes resist corrosion and tarnishing.

Installation

- Trim set requires valve to complete installation (sold separately).

Required Products/Accessories

K-304/K-P304 Series Rite-Temp® Valves

or

K-8304/K-P8304 Series Rite-Temp® Valve & Cartridge Kits

or

K-8300/K-P8300 Series Rite-Temp® Valve Body Rough-ins

K-8305/K-P8305 Series Rite-Temp® Cartridges

or

K-2971-KS 3/4" Pressure-balancing Valve

Adapters, Rough-in and Extension Kits

GP1030932 Range: 3-1/2" (89 mm) - 4-1/4" (108 mm)

Optional Products/Accessories

K-10350 Deep Rough-In Kit For K-8305 Cartridges

K-10351 Test Cap For K-8300 Series Valve Bodies

88526 Thin Wall Trim Kit



Codes/Standards

ASME A112.18.1/CSA B125.1

DOE - Energy Policy Act 1992

EPA WaterSense®







California Energy Commission (CEC)

KOHLER® Faucet Lifetime Limited Warranty

See website for detailed warranty information.

Available Colors/Finishes

Color tiles intended for reference only.

Color	Code	Description
	CP	Polished Chrome
	SN	Vibrant® Polished Nickel
	PB	Vibrant® Polished Brass
	BN	Vibrant® Brushed Nickel
	BV	Vibrant® Brushed Bronze
	2BZ	Oil-Rubbed Bronze

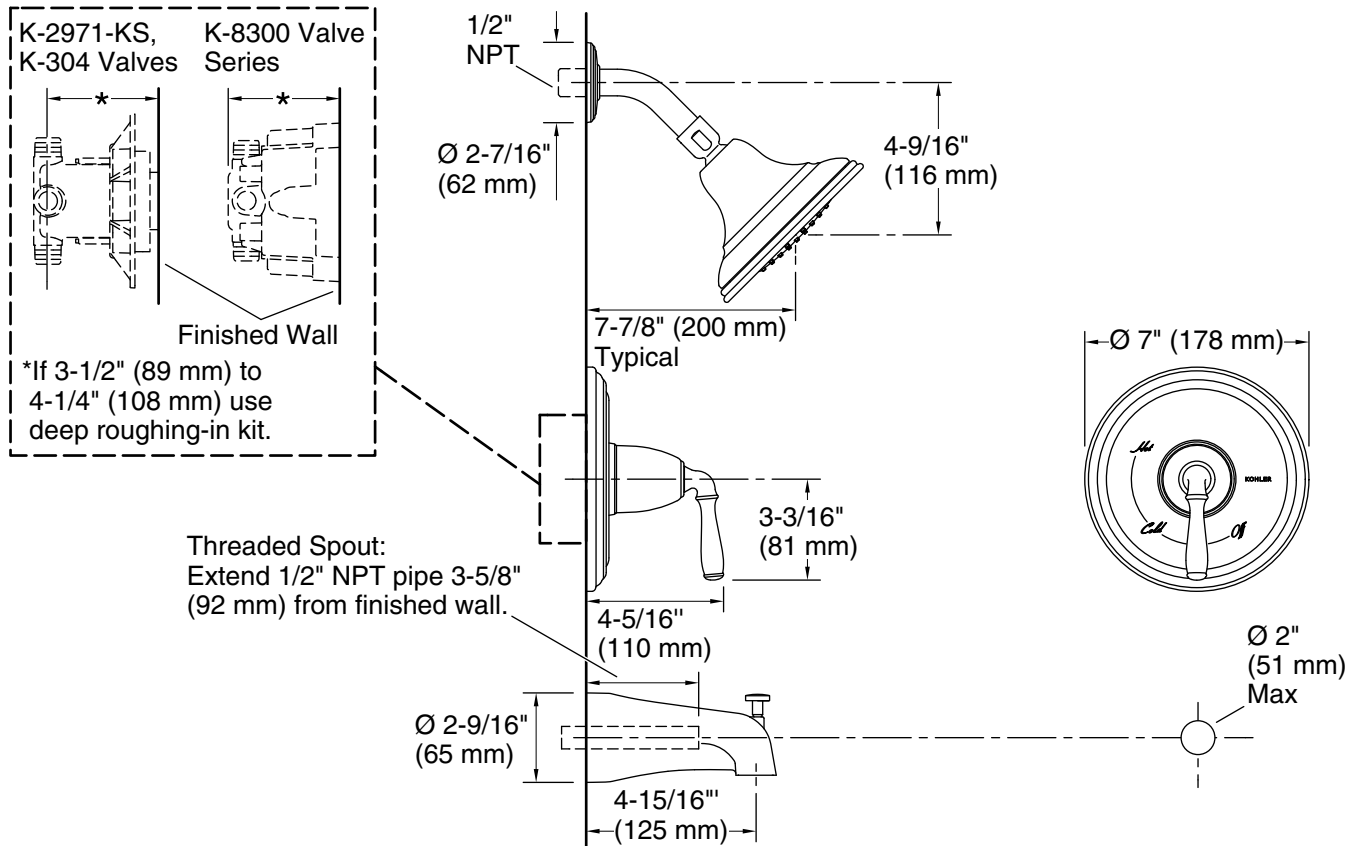

Technical Information

All product dimensions are nominal.

Drain included: No

Showerhead/Body Spray:

Rated maximum flow: 1.75 gal/min (6.6 l/min)

Pressure: 80 psi (5.5 bar)

Notes

For use with automatic compensating valves rated at 1.4 gal/min (5.3 l/min) or less.

Install this product according to the installation instructions.

Install straight pipe or tube drop of 7" (178 mm) to 18" (457 mm) with single elbow between the valve and the wall-mount spout.

NOTICE: Risk of product damage. Long screws, for installing trim, can damage the K-2971-KS valve. Consult the trim installation guide to verify if the thin wall installation kit is needed.