

**CODE NUMBER**

3451630

**DESCRIPTION**

3.5 gpf, Rough Brass Finish, Single Flush, 11-12.75 L Dimension, Electrical Override, Hardwired, Sensor-Operated, Royal® Concealed Sensor Hardwired Water Closet Flushometer.

**DETAILS**

- Flush Volume: 3.5 gpf (13.2 Lpf)
- Finish: Rough Brass (RB)
- Power Type: Hardwired (HW)
- Valve: Diaphragm
- Valve Body Material: Semi-red Brass
- Fixture Type: Water Closet
- Fixture Connection: Top spud
- Rough-In Dimension: 24" (610mm)
- Spud Coupling: 1 ½" (38mm)
- Supply Pipe: 1" (25mm)
- L Dimension: 11"-12 ¾" (279-324mm) (11-12-3/4-LDIM)
- Override: Electrical (OR)

**FEATURES**

- Flush volumes start as low as 1.28 gpf/4.8 Lpf
- Water conservation is aided by the ADA-compliant, non-hold-open handle, which prevents toilet from exceeding intended flush volume
- Flush accuracy is controlled by CID™ technology, also enhancing water efficiency
- Integrity of the product is maintained with the vandal-resistant stop cap
- Durability is facilitated with high copper, low zinc brass castings for dezincification resistance
- Adjustable tailpiece
- PERMEX synthetic rubber diaphragm with Dual Filtered Fixed Bypass
- Valve body, Cover, Tailpiece and Control Stop shall be in compliance with ASTM Alloy Classification for Semi-Red Brass
- Valve shall be in compliance to the applicable sections of ASSE 1037.

**VIDEOS**

- ▶ [ESS Flushometer](#)



**COMPLIANCES & CERTIFICATIONS**



(UL Certified, ADA Compliant, UPC Certified, BAA Compliant)

**RECOMMENDED SPECIFICATION**

Valve Body, Cover, Tailpiece and Control Stop shall be in conformance with ASTM Alloy Classification for Semi- Red Brass. Valve shall be in compliance with the applicable sections of ASSE 1037 and ANSI/ASME 112.19.2.

**ELECTRICAL SPECIFICATIONS**

- Arming Delay: 16 seconds

**VALVE OPERATING PRESSURE (FLOWING)**

15-80 PSI (103-552 kPa). Specific fixtures may require greater minimum flowing pressure - consult manufacturer requirements.

**DOWNLOADS**

- [Optima Sensor Activated Royal Installation Instructions](#)
- [Royal 140/152/153/195 ESS TMO SWB Installation Instructions](#)
- [Control Stop Repair and Maintenance Guide](#)
- [Flush Connections Flanges Repair and Maintenance Guide](#)
- [Tail Piece Repair and Maintenance Guide](#)
- [Concealed Flushometers Repair and Maintenance Guide](#)
- [Optima ESS Repair and Maintenance Guide](#)
- [Additional Downloads](#)

**NOTES**

All information contained within this document subject to change without notice.

Looking for other variations of the ROYAL 153 ESS product? [View the general spec sheet with all options.](#)

[Find a compatible urinal](#) for this flushometer.

[Find a compatible water closet](#) for this flushometer.

**Sloan 10500 Seymour Ave, Franklin Park, IL 60131**

Phone: 800.982.5839 • Fax: 800.447.8329 • [sloan.com](http://sloan.com)

**ROUGH-IN**

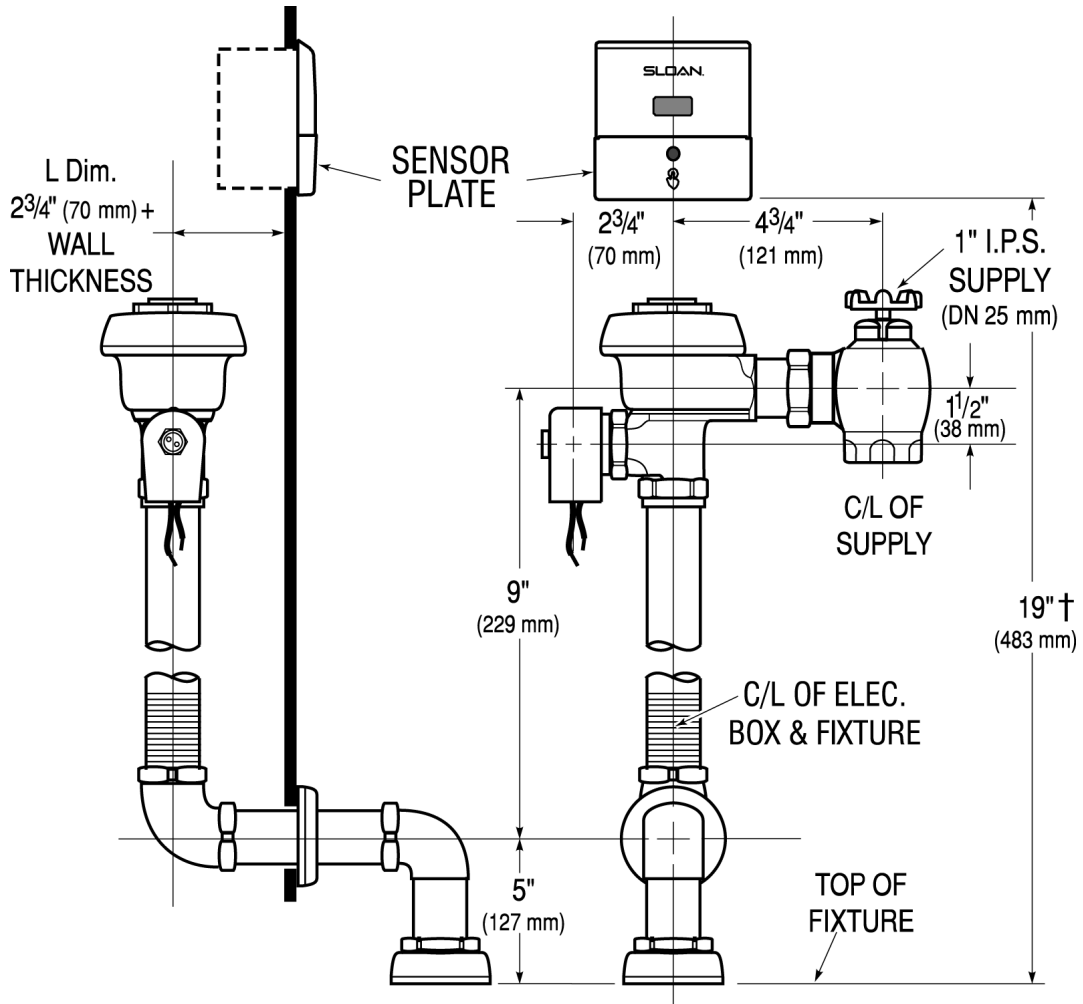

Sloan 10500 Seymour Ave, Franklin Park, IL 60131  
 Phone: 800.982.5839 • Fax: 800.447.8329 • [sloan.com](http://sloan.com)