



WE ARE IB

Collection

HERMES ELLE

Article

HL205_3

Description

Monohole washbasin with two handles complete with drain.

Box Dimensions

370x270x80 mm

Weight

3.1 kg

Finishes

- **CC**
CHROME
- **PL**
PLATINUM
- **SS**
BRUSHED
NICKEL
- **ON**
NATURAL
BRASS
- **BO**
MATT
WHITE
- **NP**
MATT
BLACK
- **CF**
BLACK
CHROME
- **CS**
BRUSHED
BLACK
CHROME
- **II**
PALE
GOLD
- **IS**
BRUSHED
PALE GOLD
- **RS**
ROSE
GOLD
- **SR**
BRUSHED
ROSE GOLD
- **OO**
GOLD
- **OS**
BRUSHED
GOLD
- **RR**
ANTIQUÉ
COPPER
- **BB**
ANTIQUÉ
BRONZE



Dimensions

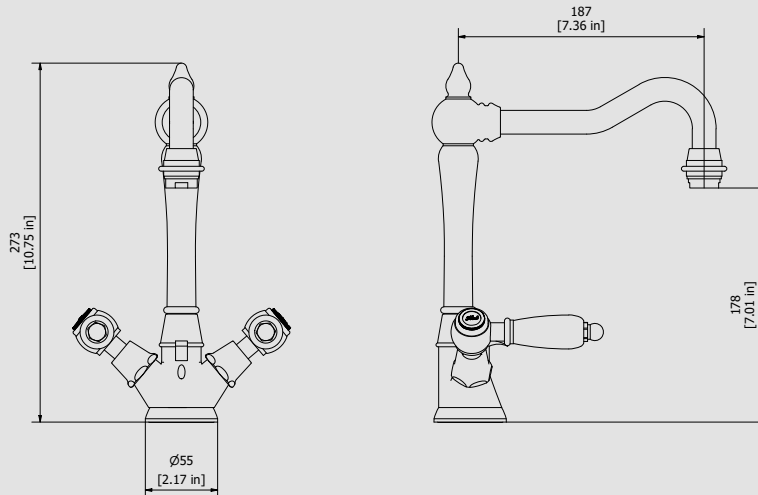

Cartridge

IB G1/2" Ceramic headworks

Threaded fitting

Inox hoses G3/8" female 400 mms long

Aerator

M24X1 perlator coin slot

Flow Rate (+/-10%)

1 BAR	2 BAR	3 BAR
9.5 l/m	13.7 l/m	16.9 l/m

Production

Main body is a single hot stamped pieces

Material

BRASS
According to CuZn42 (CW510L)
Max Lead content:0.2%

IB RUBINETTERIE s.p.a
via dei Pianotti 3/5
25068 Sarezzo (BS) - Italy -

T. +39 030 802101
F. +39 030 803097
info@weareib.it

P.IVA 01785230986
capitale sociale
€420.000,00 i.v.

www.weareib.it





WE ARE IB

ELENCO PARTI			
ELEMENTO	CODICE	DESCRIZIONE	QTÀ
1	CPKHR200CCX01	Pre mounted washbasin	1
1.1	AC0007124	Knob Ø19 M8 H27.4	1
1.2	AQ0006931	Pin M8x16	1
1.3	AC0007130	Complete spout-out	1
1.4	AQ0001320	OR 10.78x2.62 NBR 70 SH	2
1.5	AS0007129	Insert Ø18.9 G3/8" H 43 M8	1
1.6	AQ0001350	OR 11.11x1.78 NBR 70 SH	1
1.7	AC0007128	Extension Ø30 Ø27 M18x1 H139	1
1.8	AQ0001390	OR 14x2 NBR 70 SH	1
1.9	AC0009463	Base for extension Ø34 H25 G3/4"	1
1.10	AQ0010989	Rubber Ø14 Ø16 H5	1
1.11	AC0000695	Mixer body	1
1.12	AQ0003930	Ceramic headwork 90° right	1
1.13	AQ0002135	Ceramic headwork 90° left	1
2	AQ0000020	Aerator M24 x 1 perlator honeycomb (40200503301)	1
3	AC0004510	Domed nut	2
4	AQ0004525	Grip handle	2
5	AT0004520	Rod M8x1 L68.5	2
6	AC0004500	Insert for handle	2
7	AQ0013552	Handle's plug cold	1
8	AQ0009069	Cover Ø20 PLS	2
9	AQ0010985	Screw M4x12	2
10	AQ0010229	Washer Ø4	2
11	AC0003397	Lever Ø31.5 H42	2
12	AC0003100	Cap for headwork	2
13	AQ0013551	Handle's plug hot	1
14	AC0010062	Basin base Ø55xH12	1
15	AQ0010096	OR 45.7x2.62 NBR 70 SH	1
16	AQ0000932	Inox hose M10x1 G3/8" F L400	2
17	AQ0006400	Fixing set	1
18	AC0009335	Knob	1
19	AC0010414	Rod Ø5 H360	1
20	AQ0000280	PUW - PU Joint	1
21	AQ0003140	Pop-up waste 1"1/4	1

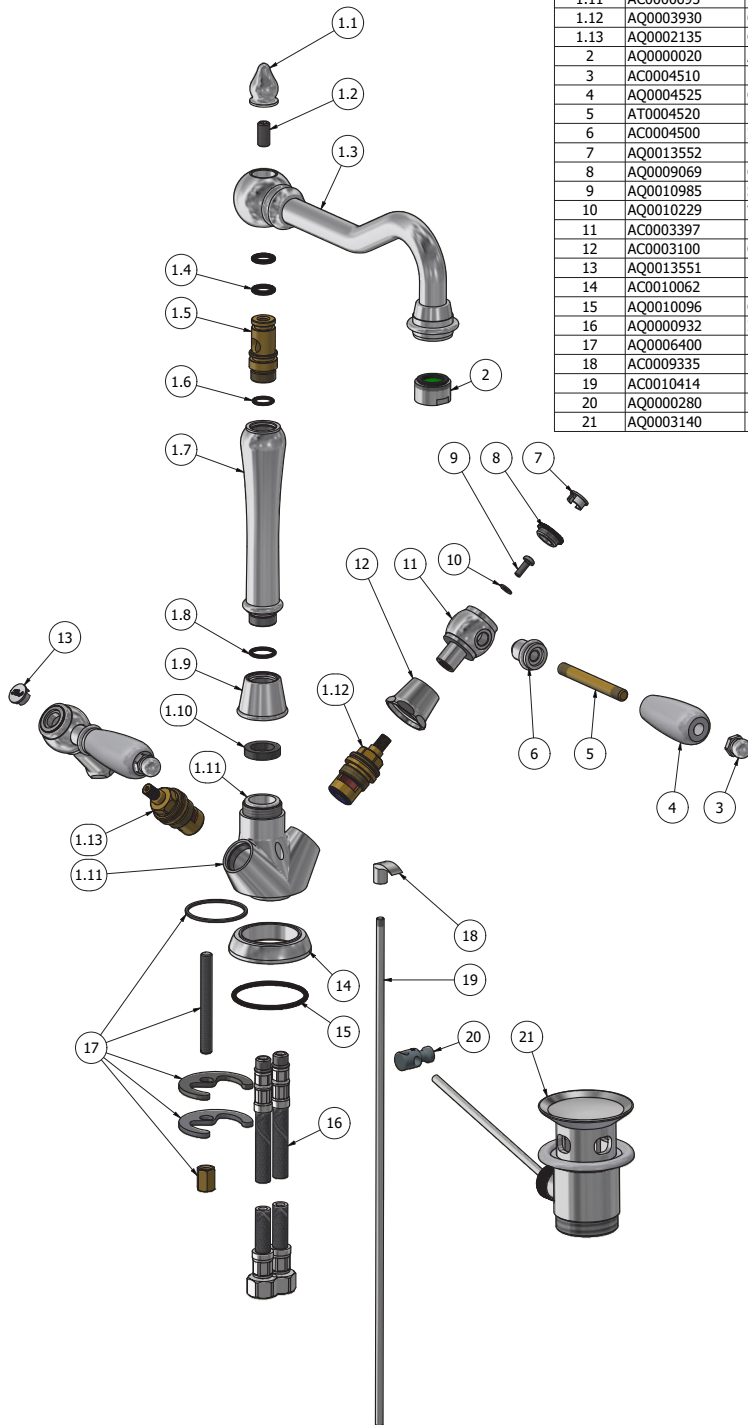



WARRANTY

All IB Rubinetterie SpA products are warranted for 10 years from the date of purchase, for the following cases:

- Defects of casting, porosity and chrome plating.
- Operating defects caused by incorrect fabrication.

The warranty provides for repair or replacement of products with fabrication defects recognized by our technical office. There is no other type of compensation anche the merchandise must be returned FOB our warehouse. The warranty only cover surface defects (scatches, dings, etc.) on fitting that have not been installed and used, returned in its original packaging with all components. O-ring, gasket seals and components subject to wear proportional to use are warranted for 2 years.

The warranty is void in the following cases:

Error installing and putting the product into service.

Deterioration of finished surfaces due to use of cleaning products containing acids or abrasive substances. Deterioration of surface with finishes other than chrome plating. Their durability is, in fact, dependent on the user's care and gentleness of use.

Deterioration of the fitting due incorrect installation.

Improper repairs and maintenance performed without the company's prior authorization.

The warranty from IB Rubinetterie SpA is not renewable.

Cleaning

We recommended cleaning the finish surfaces with water and soap, using a soft cloth.

Do not use detergents that contain hydrochloric acid or abrasive substances.

